

20106 PLAN

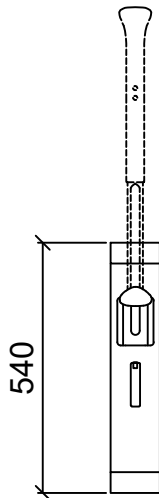

20106 FRONT

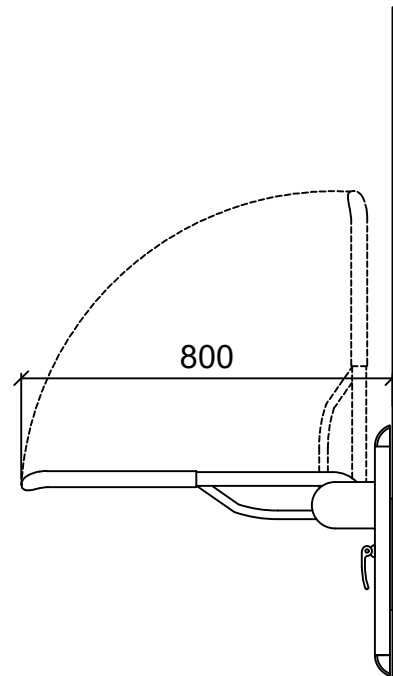

20106 SIDE