

20105 PLAN

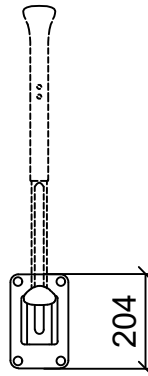

20105 FRONT

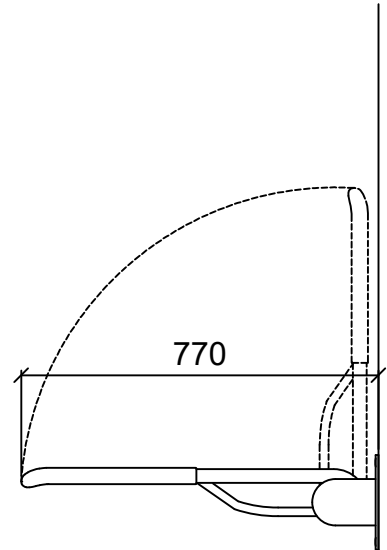

20105 SIDE