

10103 PLAN

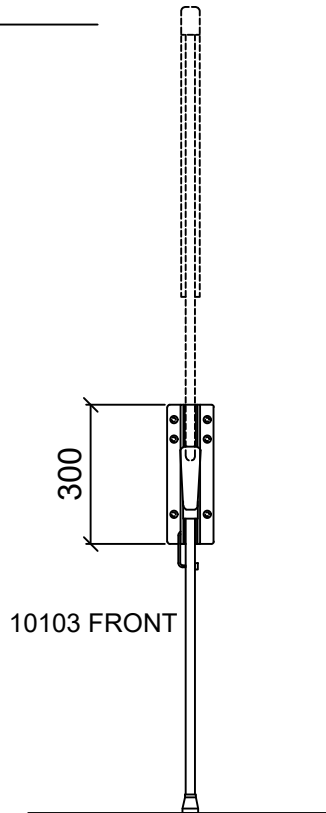

10103 FRONT

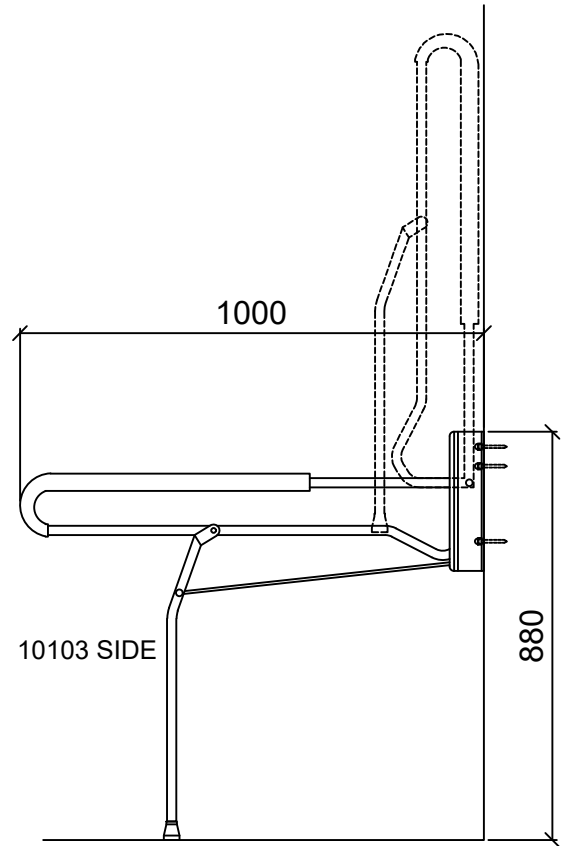

10103 SIDE